

**No. 100**  
OVAL PIPE 100" - 30 Ga.

**No. OVP114**  
OVAL PIPE 114" - 30 Ga.

**No. 160**  
OVAL PIPE 60" - 30 Ga.

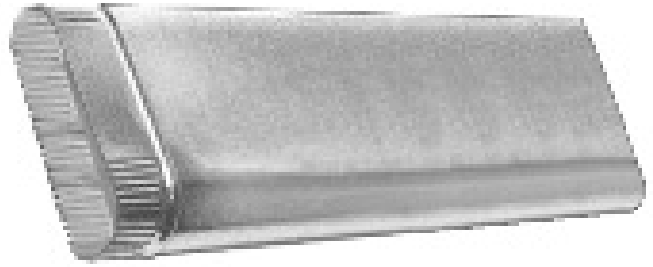

**No. 113**  
FLAT 45° ANGLE



**No. 114**  
FLAT 90° ELBOW



**No. 110**  
OVAL STACKHEAD

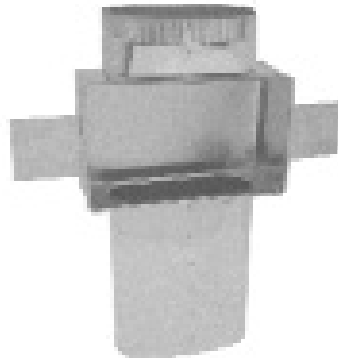

**No. 150**  
STACKHEAD w/COLLAR



**No. 106**  
OVAL to ROUND  
REVERSE BOOT



**No. 124R**  
90° REGISTER BOOT



**No. 127R**  
STRAIGHT  
REGISTER BOOT

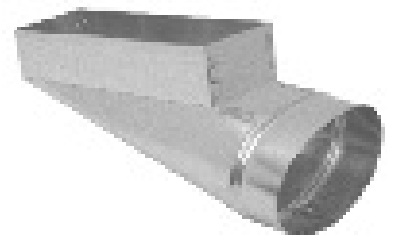

**No. 128R**  
END REGISTER BOOT

**WALL STACK vs. OVAL PHYSICAL COMPARISON**

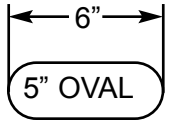
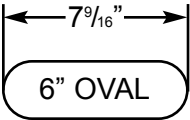
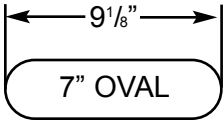
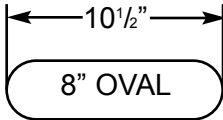
 <p>5" OVAL</p> <p>3 1/4" X 8"</p>	 <p>6" OVAL</p> <p>3 1/4" X 10"</p>	 <p>7" OVAL</p> <p>3 1/4" X 12"</p>	 <p>8" OVAL</p> <p>3 1/4" X 14"</p>
---	--	---	--



**No. 115**  
VERTICAL 45° ANGLE

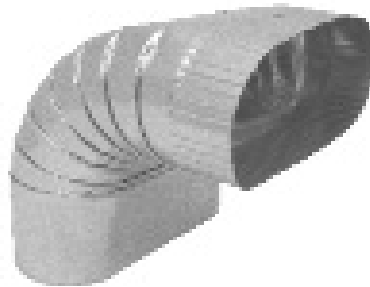

**No. 116**  
VERTICAL 90° ELBOW

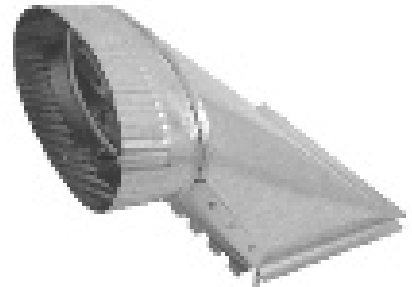

**No. 162**  
OVAL TOP TAKEOFF



**No. 127**  
OVAL to ROUND  
STRAIGHT BOOT



**No. 124**  
OVAL to ROUND  
90° BOOT



**No. 163**  
OVAL SIDE TAKEOFF



**No. 128**  
OVAL to OVAL  
REVERSE BOOT



**No. 355**  
STRAIGHT OVAL  
REGISTER BOX

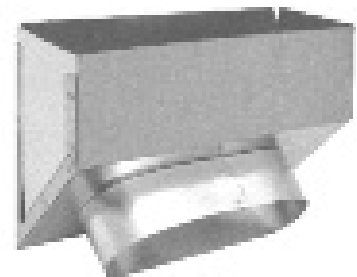

**No. 360**  
ANGLE OVAL  
REGISTER BOX